

24-Hour Hotline
400-878-1500

kaabo[®]

USER MANUAL

WOLF WARRIOR 11 MAX



Ningbo Kaabo Technology Co., Ltd.

Add: 3rd Floor, Building B3, Shanshan New Energy Base, NO. 238 Yunlin Middle Road,

Tel: 0086-0574-88321118

Email: sales@kaabo.com

Web: www.kaabo.com



Company Introduction

Kaabo Co. LTD., is a company who manufacture high quality electric scooters and accessories at market-leading prices since 2013.

Our scooter are about the joy of player. Each model has been handcrafted to give scooters true freedom. Take to the open road, or cross terrain which would be impossible on a normal scooter – Kaabo scooter push the boundaries of what's possible.

Our Story

"KAABO" focus on "high-power" electric scooters. Since 2016, the electric scooter market has become increasingly competitive.

After years of development, Kaabo has accumulated more than 25 patents, especially in terms of how to maintain the stability and safety of the vehicle under high speed and long battery life. We have obtained a lot of practical data to ensure the quality of the product.

Please read the user manual carefully.

Do not use the product until you understand its functions.

Do not rent the product to anyone who can't operate the product.

*For the first time, the user should use it with a slow speed for safety.

WOLF WARRIOR 11 MAX user manual

01. Safety guide lines and restrictions	01
02. Product structure	03
03. Name of each part	04
04. Product components	05
05. How to use the product	06
06. How to use the instrument panel	09
07. How to use the charger correctly	13
08. Safety precautions for Lithium-ion battery	15
09. Product specifications	17

Before Reading Manual

This manual contains important information to help you to use your product more safely. For safe use, it is marked as 'Danger', 'Caution' and 'Warning' depending on the degree of danger and the meaning is as below.



Danger: Indicates a hazardous situation that could result in serious injury.



Warning: Indicates a potentially hazardous situation that could result in light injury.



Caution: Indicates a potentially hazardous situation that could result in serious injury.



Caution: If the scooter is moved from low temperature environment (-20°C) to room temperature environment (10°C), don't power on it within one hour to prevent scooter is damage

Before Reading Manual

*Even if the scooter is within the warranty period, you may be liable for any accident caused by any of the following

1. Be careful of water!



This product and components are not waterproof. Don't let the water get into the product and components.

*Never use it if the road is wet due to the rain, snow, hailstorm.

*If you wash or spread water to electric devices, it can result in malfunction or fire.

2. Beware of folding and spinning parts!



If parts of the body, as a finger or hair, get caught in the spinning or folding parts of the product, this may lead to severe injuries. Please be careful.

3. No acrobatics



Stunts such as jumping and dropping are prohibited as they can cause a great impact on the product and can cause of malfunction and accidents.

4. No companion boarding



This product is intended for one adult only, so children, infants, or two people are prohibited from boarding.

5. Don't adjust by yourself



Do not open or adjust the electric parts (battery, controller or motor system).

6. Comply with the related laws



Unlicensed, drunk driving, loading cargo on the scooter is prohibited. (More than bike or bicycle license is required) Please comply with the Road Traffic Act and related laws and regulations according to the place of use.

7. Beginners and seniors are encouraged to use at low speed



Beginners who are not accustomed to use the product, seniors and others should avoid high speed mode driving and recommend low speed driving. In addition, please use after practice how to ride safely in a wide place.

8. Do not sudden brake with front brake



If there is a risk of overturning, sudden deceleration should be done safely. Do not apply any unusual behaviors or artificial forces, such as stopping with your feet.

9. Do not accelerate downhill



Slow down at downhill. When reducing the speed, to prevent brake overheat, use the brakes properly to reduce the heat on

10. Do not drive on steep slopes



Acceptable grade ability is different for each product. Excessive hill roads exceeding the specification may cause damage to the product(parts) due to temperature cut, overcurrent or low voltage cut, which may cause the product to malfunction.

11. Safety warning when lifting the product



If the product is lifted by holding only the handle, there is a possibility that the product may be damaged due to deformation of the folding part due to load or movement of the product. When lifting the product, be sure to hold the product's body (footrest) with one hand and hold the handle with the other hand so that you do not get hurt in your back or knees.

12. Be sure to wear safety equipment



For the safety of passengers, be sure to wear a full face helmet and the other protective gear(knee, elbow, hand, upper body) and do not wear shoes such as slippers, high hills that interfere with driving.

2) Precaution before driving

1. Night driving should be avoided in any case, be sure to wear helmets and other guards (knees, elbows, hands, upper body, etc.) and drive safely.
2. Select the mode that suits you and drive. In order to cope with the sudden situation, exercise to hold the brake to slow down at all times.
3. When turning left / right, slow down to avoid danger of overturning or slipping, and then turn slowly and safely.
4. To go to backward, it is safe if you getting off from the product after stopping.
5. It is prohibited to use in a slippery place, a crowded place, a steep slope, roads with a risk of accident, uneven road.
6. When crossing a pedestrian crossing, get off from the product for pedestrian safety.
7. Do not drive in threat any other means of transport, such as animals, pedestrians, bicycles, motorcycles, cars, etc.
8. If you pass the speed bumps and obstacles, be sure to slowdown.
9. When decelerating or braking, do not stop with using foot, but stop with using brake appropriately.
10. Be careful of the risk of burns due to heat from motor and brake (especially disk rotor) when driving.
11. It is prohibited to drive with all the way by holding the handle with one hand.
12. Do not ride or drive when the kick stand is down.

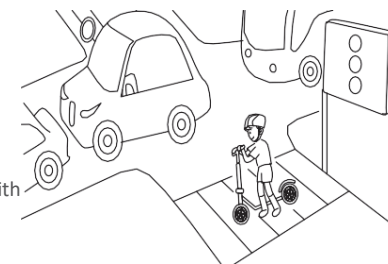

Product structure

Name of each part

Electric wiring diagram

As the drawing is too large and space is limited, please refer to the last two pages for details.

Product size

Unfolded



* Value may vary with measurement method.

Handle

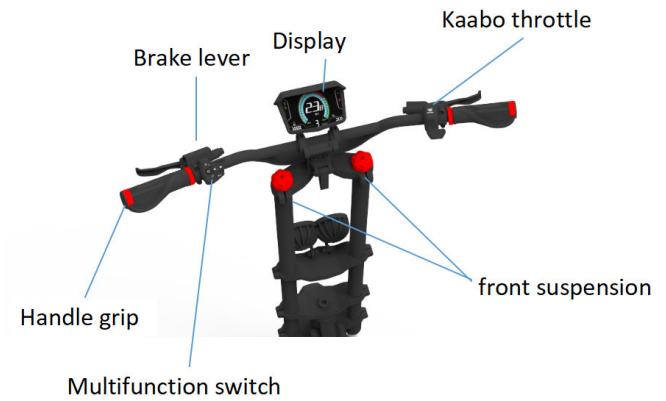

Body frame



Product components



Top:

1. Default battery charger(1.75A)
2. Default tool
3. User manual
4. Label
5. Body (Lithium battery included)



Caution

Ejecting the product number

Do not hold the handlebar only when lifting the product from the box. Please be careful that the fixing slide of the folding part may be damaged, and a safety accident such as a part of the body may be caught.

Therefore, when lifting the product, it is necessary to raise the handlebar first, and then slowly lift the body (footrest) of the product with both hands and do not damage the folding part

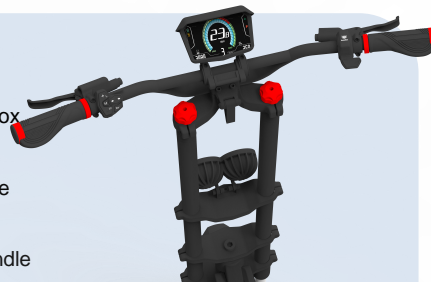

Check the instrument screws are tightened

Damping-adjustable rear suspension

Through the red adjustment knob on the rear suspension to adjust the soft and hard degree of the rear suspension, turn the adjustment knob clockwise to adjust the damping, the suspension harden, turn the adjustment knob counterclockwise to adjust the damping, the suspension becomes soft. There is 18 gears in total to meet different customers' requirements.



How to use the product

Production folding



1. Raise the handle post (Steering tube)

Release the locking clamp, raise the locking slide upwards, raise the handle post, then lower the locking slide downward.



2. Locking the folding parts

Tighten the finishing screw properly to lock the clamp, so that the locking slide is firmly fixed in any direction, and check for looseness during use.

How to use the product

1) How to start

Step1. Turning on the main switch



To turning on the product, you can start driving by turning on the main power switch first (when using the built-in battery) and turning on the power of the LCD panel. When driving is finished, turn off the LCD panel by turning off the main power.

* The power of the instrument panel will turn off automatically after a few minutes of inactivity. At this time, the LED lamp is also turned off, so turn it off with the LED lamp button when you turn it on again, and turn off the main power switch after use.

Step2. Stance for driving

After tilting the kickstand, find a stable position on the footrest and then hold the handle grip comfortably. Be careful not to raise

Step3. Acceleration and deceleration

Acceleration can be performed by using the throttle of the instrument panel while driving, and the deceleration or stop can be performed by holding the brakes on the handle.



Caution

Before driving, be sure to check the folding part, the handle part, the part where the main fixing part of the product is fastened well. And check the position of the fixing slide, the QR lever locking status and the folding part fixing status.

Throttle malfunction caution

Regardless of whether the throttle is operated or not, the motor sensor may continue to operate, causing malfunctions such as sudden acceleration. In this case, holding the brake lever to cancel the operation. This phenomenon may be caused by corrosion of the throttling, immersion of the throttle, disconnection of the magnet, broken off levers, and breakage of the spring. Do not bounce the throttle lever strongly.

How to use the product

3) How to stop

Be sure to use the rear brake first for decelerating when stopping while driving. For safe stop, it is necessary to practice slow down with rear brake.

Always use the front and rear brake levers together to stop smoothly and safely after decelerating with the rear brake.



Set the use and strength of the electronic brake among the detailed functions of the instrument panel before driving. When the brake lever works, the electronic brake works together to increase the braking force.

Tip: Check for safe braking

- For safe braking, check whether the brake lever and disc caliper connection (wire damage, external breakage, etc.) are damaged before and after driving, and check brake wear and looseness of brake inner core (inner wire). In the case of hydraulic brakes, it is also necessary to check the oil leakage or deficiency and always check that the braking force is sufficient.
- Due to various factors such as road surface condition and speed, it may not be possible to stop when brake is operated as expected. The electronic brake and ABS functions are auxiliary functions to further increase the braking force and used. The user should understand the function and expect the operation timing when use this function.

4) Product folding



How to use the instrument panel

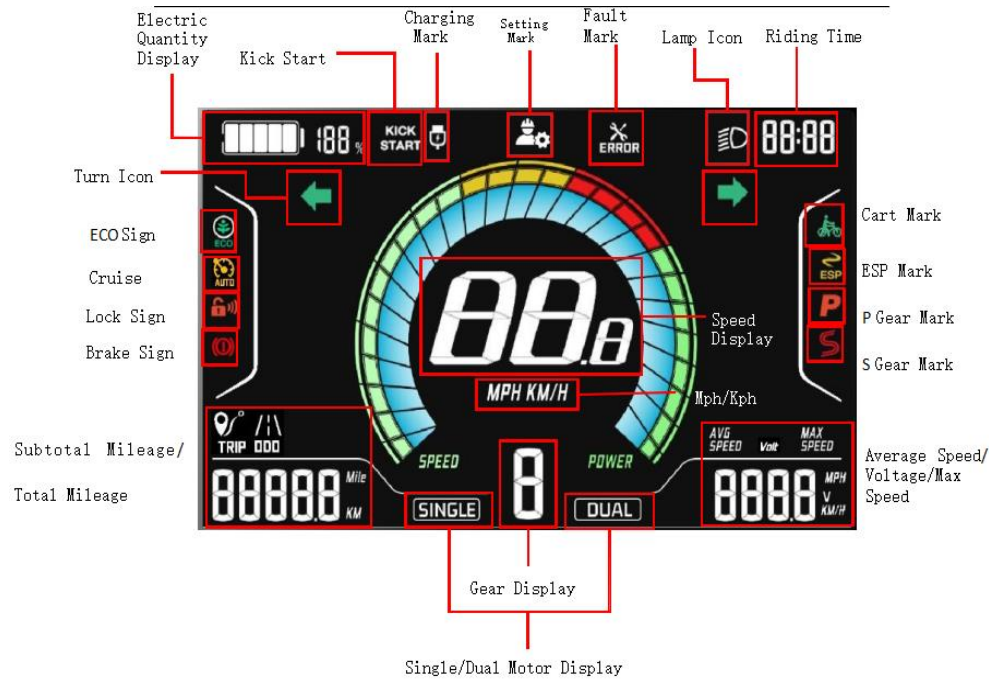

Instrument setting

MODE	description
UNT	System unit(default locking is not adjustable)
BLG	Instrument backlight Settings,1 gear,2 gear,3 gear can be selected,3 gear for the brightestbacklight mode
SLP	The automatic OFF time of scooter instrument,in minutes,is 0,5,10,10,20,30 minutes.After thesetting is complete,the scooter will automatically OFF within the set time without any operation
ESP	Electronic Stability Program 0=off 1=on (Only available if have this function)
S	Sport mode 0=off 1=on (Only available if have this function)
DSP	Instrument software version number,lock
PSd	Password set (default=1500)
TP	Theft Protection 0=off 1=on (Only available if have this function)
SET	Advanced Settings (password=1500)
RST	Reset system (Y =yes n=no)
Advanced Settings	
P1	Motor wheel diameter set,Set according to the actual wheel diameter,The general value is8-12,please do not change
P2	Speed limit as % of top speed,i.e.100=no speed limit.
P3	Motor magnetic pole setting.Default is 20 or 30.Do not change.
P4	E-ABS,1=EABS ON 0=E-ABS OFF
P5	EBS, There are five gear 1-5 1=weakest, 5 = strongest
P6	Start setting.1=non-zero start(Kick-and-Go), if the scooter is not moving,the accelerator will not work;0=Startimmediatly(note when using)
P7	Fixed speed cruise setting,0 is no fixed speed cruise,1 is automatic fixed speed cruise
P8	System voltage,48V60V72V,default 48V please do not change
P9	Undervoltage value,38V48V58V default lock 38V please do not change
P10	Starting mode,0 is hard start,a total of 5 levels can be selected,1 is the soft start,4 is the softest start (Only available if have this function)
P11	Driving mode,There are three modes: 0, 1 and 2. The drive mode can be manually adjusted in 0 mode, 1 is the default single-drive, 2 is the default dual-drive, The default mode is 2. Do not manually modify the parameters.

Pedestrian mode: Press the M key " twice to enter pedestrian mode, switch the gear and return to the state before entering the pedestrian mode, the display show pedestrian model when scooter enter this model, and the maximum speed is kept within 6km / H, and the side light flashes at 0.5 HZ until remove the mode;

P mode (packing mode) : Short press " ↑ "button or pinch the brake to remove the "P gear", the setting will maintain as the state of the last time the scooter is shutdown;

Note: For a detailed description of the Central display, see the Central display specification.

Instrument style

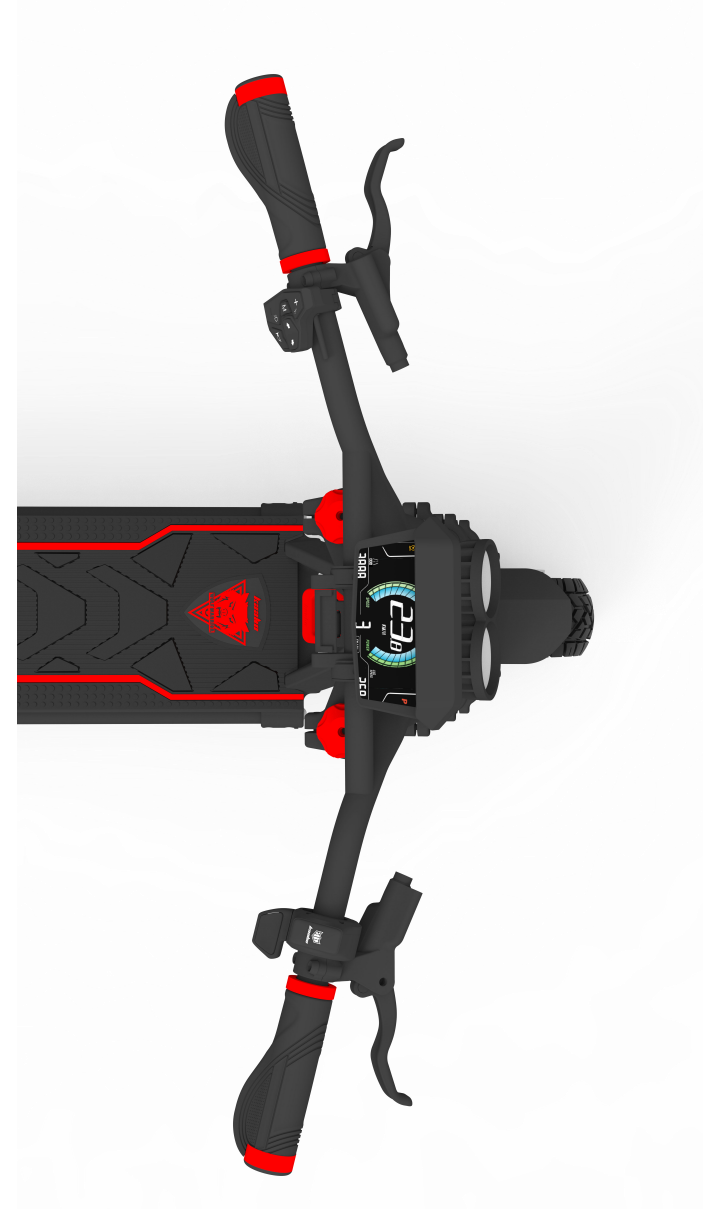

How to use a charger correctly

1) Basic charging method

1. Open the charging port cap and connect it to the connector of the charger and connect it to the household outlet.
2. Charging status indicator
3. Be sure to close the charging port cap when driving or storing except when charging.
4. When connecting the connector to the charging port, metallic sparks due to voltage difference may be splashed, but this is normal

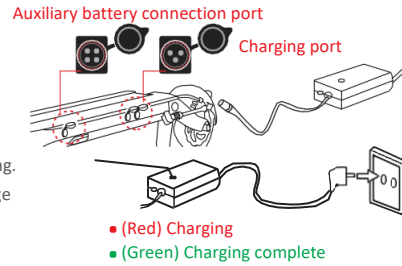

* Failure of the charger and abnormal conditions can cause electric shock and fire. Learn the correct usage and prevent safety accidents in advance.

<p>1. Manufacturers and sellers are not responsible for any problems arising from any disassembly, modification, or mixing with other chargers.</p>	<p>2. The charger is forbidden to be used in places subject to high humidity, heat, flammable materials, confined spaces, or where there is no ventilation such as in a car.</p>
<p>3. The charger is not waterproof. It is thoroughly controlled to prevent moisture from entering the charger.</p>	<p>4. Children and pets should not be allowed to approach the charger when they come into contact with them, as they may cause an electric shock.</p>
<p>5. If the charger lamp does not light, charger fall, strong external shock, long time charge, or cable cover damage, discontinue use immediately and contact the service center.</p>	<p>6. Unplug the charger when you are away from the home for long periods of time.</p>

7. Use only genuine charger.
8. Do not insert conductors into the charging port.
9. Do not touch the plug for about 10 seconds after unplugging the charger. There is a risk of electric shock from instantaneous discharge.
10. Do not remove the terminal during charging. Charge the internal circuit of the charger and cause malfunction.
11. Do not operate the product during charging.
12. Charging terminals should be firmly contacted during charging and should not be used if terminals are corroded or damaged.
13. When disconnecting the charger from the product, it is safe to hold the terminal without holding the wire.



***Short-circuit Caution:** Be careful not to short-circuit the battery because short-circuiting of the battery is very dangerous.

***Over current Note:** The battery of this product is designed to automatically shut off the power supply to protect the battery when the over current is over 100A.

***Low Voltage Caution:** The battery of this product is designed to be automatically shut off when the voltage drops below 48V. Do not use the product in the low voltage state.

Safety precautions for Lithium battery

1. Care Lithium batteries should be protected from direct exposure to children and pets.
2. Performance
 - ① Lithium battery is affected by external temperature. In winter, when the temperature is low, the performance of the battery is temporarily deteriorated and the mileage and power output is reduced.
 - ② Lithium battery has a characteristic that discharge performance is reduced by more than 15% when charging / discharging 300 times or more. If usage time is shortened due to long usage, it should be replaced with a genuine one through the nearest point.
3. Charging
 - ① Lithium battery should be used only with genuine battery and charger supplied from the manufacturer. Any problems caused by use of battery made by the manufacturer, mixed use, or using the charger are not covered by the manufacturer.
 - ② Charging the lithium battery with a non-genuine charger may cause malfunction or fire.
 - ③ The lithium battery should be charged in a well-ventilated, dry place and around the charger in a place where there is no inflammable material.
 - ④ Lithium battery should be charged at 0 ~ 45 °C and discharged within -10 ~ 60 °C. Charging or discharging at a temperature outside this range may cause malfunction, fire or explosion.
 - ⑤ In case of moving from cold outside to warm indoor, please charge it after 1 ~ 2 hours. This is to prevent condensation from occurring inside the product due to temperature difference.
4. Storage
 - ① Lithium batteries should be kept away from snow, rain and direct sunlight. Do not store or charge them in a trunk or hot room. Select a dry place and store at room temperature (10 ~ 20 °C).
 - ② When storing for more than 3 months, charge the remaining battery level to 70 ~ 80% (do not store full charge).
5. Trouble symptom, safety
 - ① Lithium battery should be discontinued immediately if it is damaged or leakage of battery, sour odor, appearance deformation, etc., and contact the place of purchase to get technical support and service.
 - ② If overheat, smoke or ignition is detected in a product with lithium battery, immediately stop charging and use, move the product outdoors as soon as possible, and then use a fire extinguisher to evolve. Do not spray water or immerse the product in order to evolve, which is more dangerous.
 - ③ Lithium battery pack has very high energy density, so if you charge the battery for a long time in case of



short-circuit, leakage, bad battery, etc., there is a possibility of ignition. Therefore, you should avoid charging for a long time without a person, and charging must be done while the person is aware that the risk of unexpected fire can be avoided.



6. Misuse If the lithium battery is short-circuited or the polarity is changed, or if the battery is impacted, malfunction or fire may result. If you think that the battery has been impacted, you should stop charging and using it and visit the nearest point for inspection.
7. Water inflow It should be controlled to prevent water inflow into the lithium battery. There is a risk of fire or electric shock if the charger is connected while moisture is present.
8. Caution Disconnect the battery from the main unit and prohibit recharging, reinstalling, or using other applications.
9. Disposal Disposal When disposing of the lithium battery, the battery should be separated from the product at the point of purchase or near the point so that the charge and discharge terminals are not short-circuited. Dispose of it as industrial waste when disposing of it.



Battery disassembly prohibited

Danger Battery disassembly, modification and repair are not covered under warranty.

Product Specification

 WOLF WARRIOR 11 MAX	
Product category	EN 17128 CLASS 2
Configuration	60V 36AH
Color	
Battery Type	DMEGC21700
Battery Capacity	INR21700-45E
Motor	1500W X2
Max Speed	25km/h
Max Range	150km(75kgs load,25km/h flat road ride at constant speed,full of electricity,sufficient air pressure)
Climbing Angles	<45°
Max Load	120KG
Charger	67.2V 1.75A 1+ 2- (2pcs)
Charging time (use 1.75AX2)	About 10.3 hours (use 1.75A X2)
Charging time (use 5A X2)	About 3.6 hours (use 5A X2, Customers are required to purchase 5A chargers)
Shock Absorber	Spring-adjustable front motor suspension (Dual steam)Damping-adjustable rear suspension
Brake	From and rear hydraulic brake (160) +ABS
Light System	Front and rear turn lights Driving Light LED Chassis light+LED frond spotlight

Horn	Motorcycle-grade horn
Controller	60V 50A *2
Open Size	1340mm*748mm*1336mm
Floding Size	1640mm*748mm*448mm
N.W.	56KGS
G.W.	66KGS
Tyres	11 inch all-terrain explosion-proof vacuum tires CST
Display	Center display +kaabo accelerator
Certificat es	IPX5 CE(EMC MD LVD) ROHS FCC
Product Material	handle, frame, bar material:6061- t6 aluminum alloy and6082- t6 aluminum forging;Cover pp; Shaft scm440;

*The specification can be changed by manufacturer without notice to improve the quality and safety for users.

*The distance can be affected by loaded weight, wind direct (wind speed), road condition, slope and tire condition.

Wolf Warrior 11 Max wiring diagram

Wiring Requirement:

- A: Glue the internal circuit plug-in to secure it.
 B: Taboos for internal wiring (unacceptable in the following ways).
- 1: Line not effectively fixed (random line)
 - 2: The line is tightly welded for single fixation.
 - 3: The line may touch sharp places (if the line passes through sharp places, it is necessary to wrap the sharp places to prevent the line from being cut and resulting in short circuit problems)
 - 4: Other incorrect wiring methods that may result in reverse connection, loose plug, short circuit, or incorrect plug

